

# 25.6V 2.5KWH

## LiFePO4 Rack-Mounted Home Energy Storage Battery Solution



CONNECT WITH  
OFFGRID/HYBRID  
INVERTER



BACKUP  
BATTERY



LITHIUM-ION  
BATTERY



3 YEAR PRODUCT  
WARRANTY

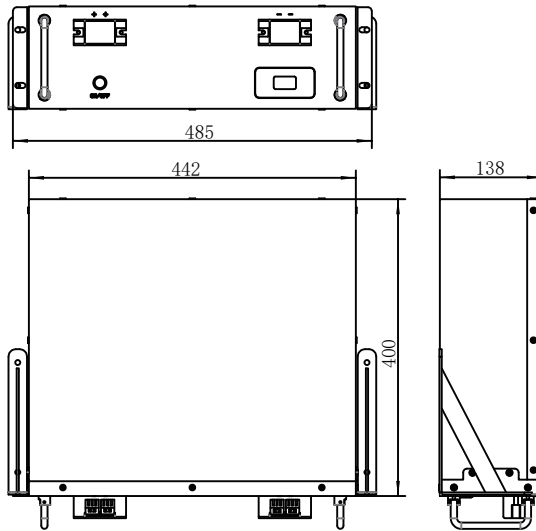

Dimension Drawing

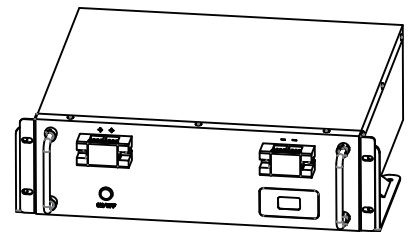

## Compatible Inverter



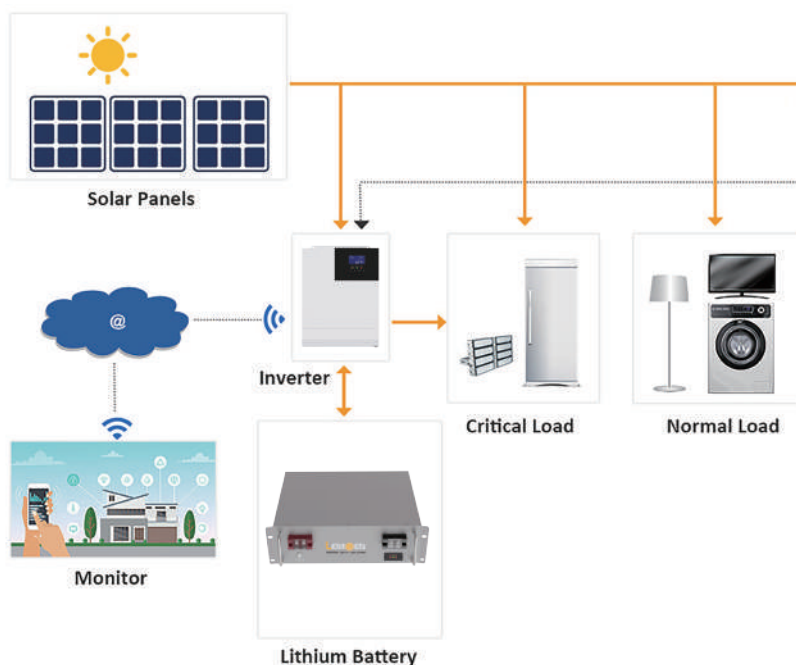

## Parameters

### ECO 2.5

Nominal Energy	2.5kwh
Nominal Voltage	25.6V
Nominal Capacity	100Ah
Cell Type	LFP
Standard Charge Voltage	29.2V
Max Charge Current	120A
Discharge Cut-Off Voltage	20V
Max Discharge Current	120A
Parallel Function	Support Connection In Series & Parallel
Load Power	≤3000W
Calendar Life	6+ Years @25°C
Cycle Life *	≥3000 Cycles
Charge temperature range	0~65°C
Discharge temperature range	-20~65°C
Certification	Cell:UL1642 / IEC62619 / CE / ROHS / MSDS / UN38.3 Pack:MSDS / UN38.3
Dimensions	442*440*138mm(Without ear)
Weight	24.5Kg±0.3
Installation method	Wall mounted/Rack Mounted

\*Test Condition: 80% DOD, 0.2C charge & discharge @25°C

● **Different current/Temperature Discharge curves**

Different Rate Discharge Curve @25°C

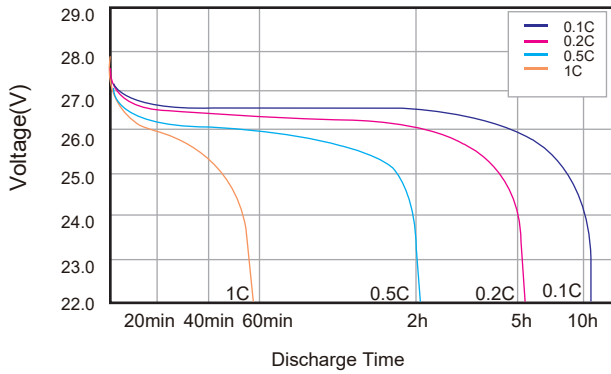

Different Temperature Discharge Curve @0.5C

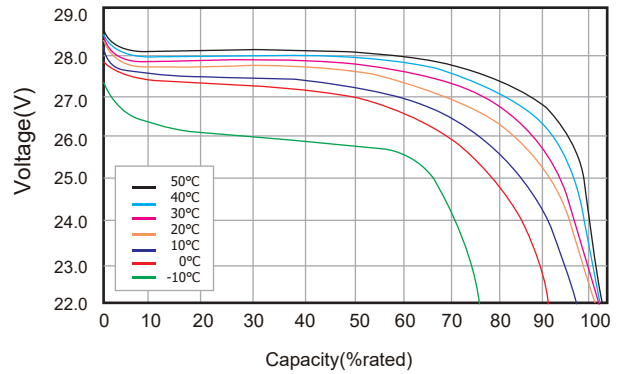

● **Charging and Discharge curve**

Charge and Discharge at 25°C,0.5C

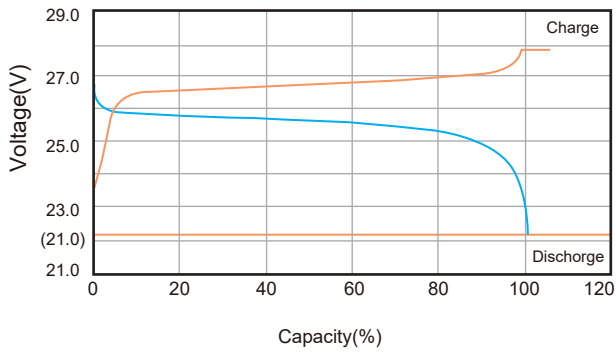

Different Temperature Self Discharge Curve

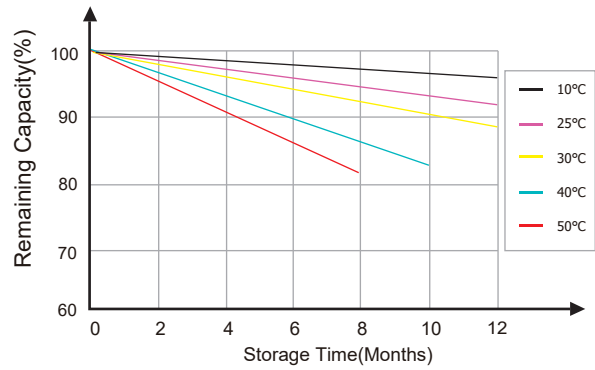

● **Cycle Life Curve**

Different Discharge Depth Life Curves & 25°C,0.5C

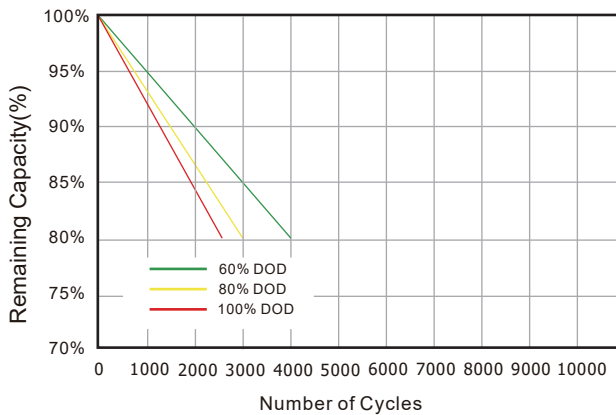

Different Discharge Depth Life Curves & 40°C,0.5C

