

SNA5000 TRAINING

Part 1: WI-FI DONGLE

1. Setting Up an Account (Ask your distributor for an installer account)
2. Connecting Wi-Fi Dongle to Clients Wireless Internet (10M Max Radius)
3. How to Use Luxpower Monitor Page
4. Tips & Tricks

Part 2: Installation Requirements

1. AC Side
 - 25 Input Breaker
 - 20 /25A Output Breaker
 - Earth Leakage
 - SPD (275V)
 - Lights Grid/Inverter
 - Changeover Switch (Required to bypass inverter)
2. DC Side
 - Strings Must Have Fuses (+ & -)
 - (100V – 385V & 13A Per MPPT) **Max Voltage = 480V**
 - SPD (500V)
 - Isolator Switch
 - Battery Disconnect Box (125A Fuses & 35mm Cable)

Part 3: Settings (Online) - Login page: <http://server.luxpower.com>

Common Setting

Time (?)	<input type="text" value="yyyy-MM-dd HH:mm:ss"/>	<input type="button" value="Set"/>	PV Input Mode	<input type="text" value="0: DC source mode"/>	<input type="button" value="Set"/>
Battery Type (?)	<input type="text"/>		Lead-acid Type	<input type="text"/>	
Lithium Type	<input type="text"/>	<input type="button" value="Set Battery"/>			
Nominal Battery Voltage(V)	<input type="text" value="[40, 59]"/>	<input type="button" value="Set"/>	Green Function Enable (?)	<input type="button" value="Enable"/>	<input type="button" value="Disable"/>
Normal / Standby (?)	<input type="button" value="Normal"/>	<input type="button" value="Standby"/>	Buzzer Enable	<input type="button" value="Enable"/>	<input type="button" value="Disable"/>

Charge Setting

Charge Current Limit(A) (?) [0, 110/4480] Set

Lead Acid

Charge Voltage(V) (?) [50, 59] Set

Floating Voltage(V) (?) [50, 56] Set

Equalization Voltage(V) (?) [50, 59] Set

Equalization Period(Days) (?) [0, 365] Set

Equalization Time(Hours) (?) [0, 24] Set

AC Charge

AC Charge (?) Disable Set

AC Charge Battery Current(A) (?) [0, 60] Set

AC Charge Start Time 1 [0, 23] : [0, 59] Set

AC Charge Start Time 2 [0, 23] : [0, 59] Set

AC Charge Start Time 3 [0, 23] : [0, 59] Set

AC Charge End Time 1 [0, 23] : [0, 59] Set

AC Charge End Time 2 [0, 23] : [0, 59] Set

AC Charge End Time 3 [0, 23] : [0, 59] Set

AC Charge Start Battery Voltage(V) (?) [38.4, 52] Set

AC Charge End Battery Voltage(V) (?) [48, 59] Set

AC Charge Start Battery SOC(%) (?) [0, 90] Set

AC Charge End Battery SOC(%) (?) [20, 100] Set

Generator Charge

Generator Charge Type According to Battery Set

Generator Charge Battery Current(A) [0, 60] Set

Generator Charge Start Battery Voltage(V) (?) [38.4, 52] Set

Generator Charge End Battery Voltage(V) (?) [48, 59] Set

Generator Charge Start Battery SOC(%) (?) [0, 90] Set

Generator Charge End Battery SOC(%) (?) [20, 100] Set

Application Setting

EPS Voltage Set(V) (?) 208 Set

EPS Frequency Set(Hz) (?) 50 Set

AC Input Range (?) 0: APL(Utility Range90-280V) Set

Max. Generator Input Power(W) (?) [0, 7370/65534] Set

AC First (?)

AC first Start Time 1 [0, 23] : [0, 59] Set

AC first Start Time 2 [0, 23] : [0, 59] Set

AC first Start Time 3 [0, 23] : [0, 59] Set

AC first End Time 1 [0, 23] : [0, 59] Set

AC first End Time 2 [0, 23] : [0, 59] Set

AC first End Time 3 [0, 23] : [0, 59] Set

Hybrid Setting

PV&AC Take Load Jointly (?) Enable Disable

Export to Grid (?) Enable Disable

Export Power Percent(%) (?) [0, 100] Set

Parallel Settings

Set System Type (?) Set

Battery Shared (?) Enable Disable

Set Composed Phase (?) Set

Discharge Setting ▼

Discharge Control (?) <input type="text" value="According to Voltag"/> <input type="button" value="Set"/>	Discharge Current Limit(A) (?) <input type="text" value="[0, 110/4480]"/> <input type="button" value="Set"/>
Battery Warning Voltage(V) (?) <input type="text" value="[40, 50]"/> <input type="button" value="Set"/>	Battery Warning SOC(%) (?) <input type="text" value="[0, 90]"/> <input type="button" value="Set"/>
Discharge Cut-off Voltage(V) (?) <input type="text" value="[40, 50]"/> <input type="button" value="Set"/>	Discharge Cut-off SOC(%) (?) <input type="text" value="[0, 90]"/> <input type="button" value="Set"/>
On Grid EOD Voltage(V) (?) <input type="text" value="[40, 56]"/> <input type="button" value="Set"/>	On Grid EOD SOC(%) (?) <input type="text" value="[10, 90]"/> <input type="button" value="Set"/>

Other Setting ▼

CT Power Offset(W) <input type="text" value="[-200, 200]"/> <input type="button" value="Set"/>	
Fan 1 Max Speed(%) <input type="text" value="[50, 100]"/> <input type="button" value="Set"/>	Fan 2 Max Speed(%) <input type="text" value="[50, 100]"/> <input type="button" value="Set"/>

Reset ▼

All to Default

Part 4: Settings & Working Modes (LCD Screen)

1. Inverter to Use Solar + Battery Then Grid/utility:

- **Setting 14: AC Charge Disabled**
- **Setting 15: AC First - All Time Values Must be Set to 00:00 for All 3 Time Intervals (Example, P1 00:00 Start & P1 00:00 End)**
- **Setting 12: On Grid EOD - Set to Desired Level Point at Which the Grid/Utility Will Take Over From Battery**
- **Setting 11: Cut Off Voltage/SOC**

2. Solar to Supply Loads During Day Time and Battery for Backup Use Only:

- **Setting 14: AC Charge Disable**
- **Setting 15: AC First - All Time Values Must be Set to 00:00 for All 3 Time Intervals (Example, P1 00:00 Start & P1 00:00 End)**
- **Setting 12: On Grid EOD - Set to Desired Level Point at Which the Grid/Utility Will Take Over From Battery (Set to 90%)**
- **Setting 11: Cut Off Voltage/SOC (Roughly 20%)**

3. Using the Inverter as a Backup Power Supply (No Panels):

- **Setting 14: AC Charge Enabled - Set According to Time, then for Interval Time P1; Set to 00:00 Start and 23:59 End.**
- **Setting 15: AC First - Set Interval Time P1 to 00:00 Start and 23:59 End.**
- **Setting 12: On Grid EOD - Set to 90%**
- **Setting 11: Cut Off Voltage/SOC (Roughly 20%)**

NB: Setting Tips

- **Setting 3: Battery Setting - Set this First**
- **Setting 6: Inverter with New Firmware (246771) - There are 3 Different Charge Rates: 1st (Lead-Acid); 2nd (AC Charge) & 3rd (Gen Charge)**
- **Setting 10: SOC Must Only be Used For Battery That Has Full Communication and Voltage on Lead-Acid Settings**
- **When Using a Small Generator, Try Not to Use More than 50% of the Generators Capacity**
- **All References for Settings is in the Manual**

Part 5: Battery

1. Check Battery Compatibility List
2. Battery Communication Pin out

CAN Communication

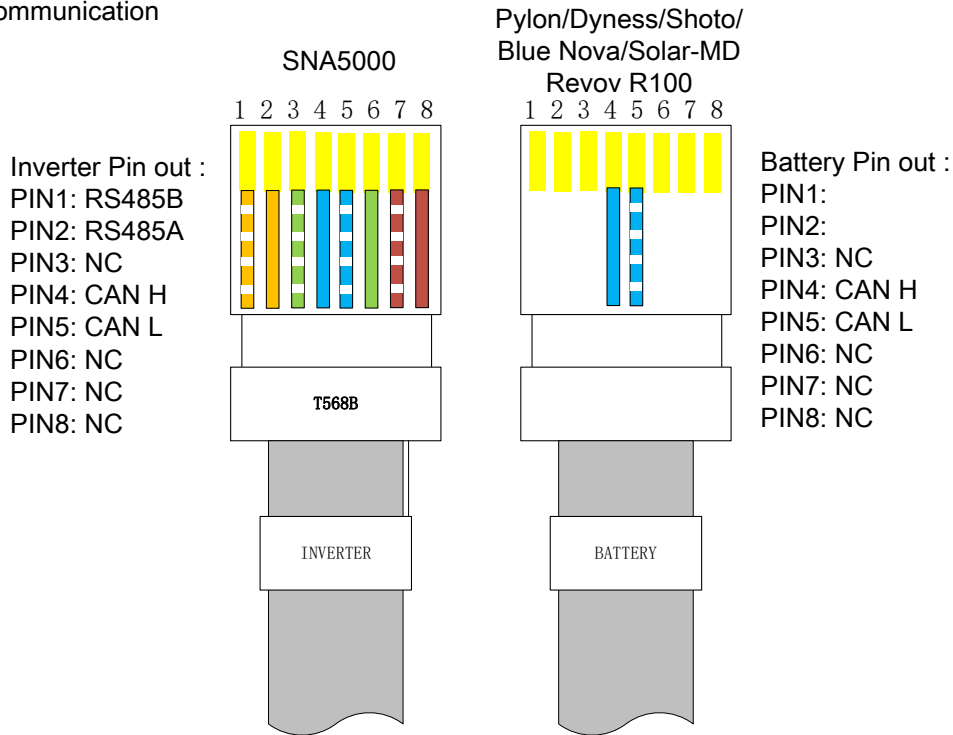

CAN Communication

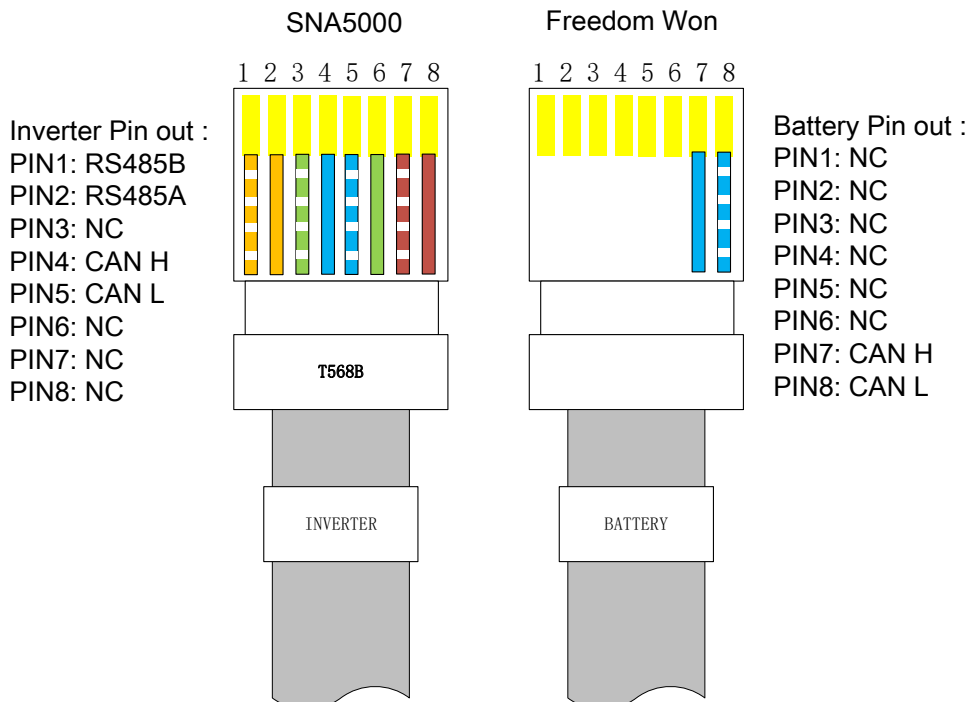

Part 6: Parallel Settings

1. DIP Switches on **FIRST & LAST** Inverter Must be ON and All Inverters in the Middle Must Be Off
2. Communication Cable Between the Inverters is a Straight RJ45 Cable
3. Max Inverters in Parallel is 10
4. One Battery Module Per Inverter Can Work or All Can Share a Battery
5. Cannot Share a String Between 2 Inverters
6. Master Inverter is Determined by the 1st Inverter that is Switched On while in Parallel

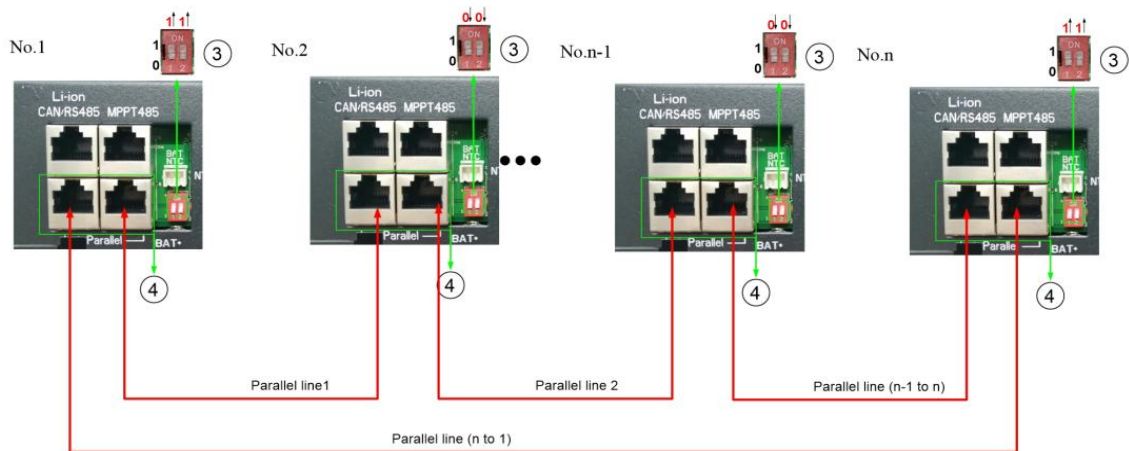

Parallel Settings

Set System Type (?)

Battery Shared (?)

Set Composed Phase (?)

CODES AND DESCRIPTIONS

List

1. Status Codes.....	1
2. Error codes and Troubleshooting.....	3

1. Status Codes

There is a status code at the bottom of the screen showing the inverter's current status. You can also find a face icon on the left of the status code.



If the status code is coming along with a smiling face icon, that means the inverter is in normal operating status.

























e.g. the status code on the 2 images below is 0x40 and 0x14 respectively.











If with a neutral face icon, the inverter is in warning status. The code after the neutral face is a warning code. If a sad face icon is showing, the inverter is in fault status. The code represents the error code. Please refer to the troubleshooting chapter of the user manual for the meaning and countermeasures of the warning code and error code.









Below is the explanation of the normal status code(status code coming with a smiling face icon),



Status Code	Inverter Status	Explanation
0x00 	Standby	Inverter in standby status
0x02 	FW Updating	The inverter is updating FW
0x04 	PV On-grid	PV grid-tied status, solar power is first used to supply load, If solar power>load power, excess solar power is fed into the grid; If solar power<load power, insufficient part is drawn from The grid.

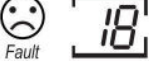



<p>0x08</p>  	PV Charge	Solar power is used to charge batteries only. The max solar power will be limited to max battery charging power. This status often appears when the EPS switch is turned off.
<p>0x0C</p>  	PV Charge On-grid	Inverter in hybrid mode(PV&AC Take Load Jointly enabled), and solar power>load power. Solar power is first used to supply load, with the excess part charging the battery.
<p>0x10</p>  	Battery On-grid	Inverter in hybrid mode(PV&AC Take Load Jointly enabled), Battery discharges to supply load, the insufficient part is drawn from the grid.
<p>0x11</p>  	Bypass	Inverter in off-grid mode(PV&AC Take Load Jointly disabled), and load is supplied by grid power only.
<p>0x14</p>  	PV&Battery On-grid	Inverter in hybrid mode(PV&AC Take Load Jointly enabled), 1. Solar power< load power, solar and battery are supplying load together. Or, 2. Inverter in AC First time period. Or, 3. Inverter in AC Charge time period while AC Charge requirement not met.
<p>0x19</p>  	PV Charge + Bypass	Inverter in off-grid mode(PV&AC Take Load Jointly disabled), Load is supplied by grid power only, while solar power is used to charge the battery only and limited to max battery charging power.
<p>0x20</p>  	AC Charge	Grid power is supplying load and charging battery simultaneously.
<p>0x28</p>  	PV&AC Charge	Battery is being charged by solar and grid power simultaneously, load is supplied by grid power.
<p>0x40</p>  	Battery Off-grid	Grid power is cut, and the battery is discharging to supply load.
<p>0x80</p>  	PV Off-grid	Grid power is cut, and the inverter is supplying the load with available solar power.
<p>0xC0</p>  	PV&Battery Off-grid	Grid power is cut, the inverter is supplying load with solar and battery power together.
<p>0x88</p>  	PV Charge Off-grid	Grid power is cut, and solar power is supplying power to load and charging the battery simultaneously.









2. Error codes and Troubleshooting













Fault Code	Fault description	Troubleshooting
Fault 00 	Internal communication fault1	<ol style="list-style-type: none"> 1. Please try to restart the inverter to remove the error ; 2. Please check if the firmware update had been done completely ; 3. If the steps above do not work, please contact Luxpowertek
Fault 01	Rsvd	Undefined
Fault 02 	BatOnMosFail	<ol style="list-style-type: none"> 1. Please check the voltage sample after the Anti-reversed MOS, and the battery voltage sample; 2. Please compare the voltage reading above, the difference should be less than 2V; 3. If the steps above do not work, please contact Luxpowertek
Fault 03 	CT Fail	<ol style="list-style-type: none"> 1. Please try to restart the inverter to remove the error ; 2. If the step above does not work, please contact Luxpowertek
Fault 04	Rsvd	Undefined
Fault 05	Rsvd	Undefined
Fault 06	Rsvd	Undefined
Fault 07	Rsvd	Undefined
Fault 08 	CAN communication error in Parallel System	<ol style="list-style-type: none"> 1. Please check if it is the parallel system, If no, please set "NO Parallel" 2. Please check if the parallel cable looks OK, and it should be the Cat-5 straight-wired cable ; 3. Please check if the configuration of DIP switches on inverters is OK please refer to the parallel connection guidance.
Fault 09 	master lost in parallel system	This code is not for Eco-Hybrid
Fault 10 	Multi-master in parallel system	This code is not for Eco-Hybrid
Fault 11 	AC inconsistent in parallel system	<ol style="list-style-type: none"> 1. Please make sure the L, N consistency of the AC input, does not reverse the L, N connection; 2. Please check the breaker status per phase and make sure they are on or off at the same time
Fault 12 	Off-grid output short circuit	<ol style="list-style-type: none"> 1. Please power off the inverter 2. Please check if there is a short circuit issue of the load side 3. Please check if the L, N connection of one of inverters has been reversed.

Fault 13 	UPS reserve current	<ol style="list-style-type: none"> 1. Please check if the parallel inverters have been set as "No Parallel ",Please set them as "Single-phase Parallel" ; 2. Please check if the parallel cable looks OK, and it should be the Cat-5 straight-wired cable ; 3. Please check if the configuration of DIP switches on the inverters are OK ,please refer to the parallel connection guidance. 4. Please check if you have paralleled the AC input and AC output
Fault 14	Rsvd	Undefined
Fault 15 	Phase Error in three-phase parallel system	<ol style="list-style-type: none"> 1. Please check if it is a three-phase parallel system, if no, please set"Single-phase parallel " or "No Parallel" accordingly 2. If it is a three-phase parallel system,please check if it is the issue of the lack of phases 3. Please check LN connection and breaker status
Fault 16 	Relay fault	<ol style="list-style-type: none"> 1. Please restart the inverter to make it work in "ON-grid"mode,and see if the error has been removed ; 2.Please check if there is big difference of the voltage reading of both AC input and output ; 3.If the steps above do not work,please contact Luxpowertek
Fault 17 	Internal communication fault2	<ol style="list-style-type: none"> 1. Please try to restart the inverter to remove the error ; 2. Please check if the ribbon cable between the MPPT board and control board is firmly connected; 3. Please check if the firmwares for both comm and MPPT are well done ; 4. If the steps above do not work,please contact Luxpowertek
Fault 18 	Internal communication fault3	<ol style="list-style-type: none"> 1. Please try to restart the inverter to remove the error ; 2. Please check if the firmwares for both Comm and DSP are well done ; 3. If the steps above do not work,please contact Luxpowertek
Fault 19 	Bus voltage high	<ol style="list-style-type: none"> 1.Please check if the PV input voltage is too high to work (refer to the name plate) 2.Please contact Luxpowertek to fix.
Fault 20 	EPS connection fault	<ol style="list-style-type: none"> 1. Please check if the AC input is installed to AC output port 2. If the step above do not work,please contact Luxpowertek
Fault 21 	PV voltage high	Please turn off the PV input and check if the PV input voltage is too high to work (refer to the name plate) ,and try to reduce the panels.
Fault 22	Rsvd	Undefined
Fault 23	Rsvd	Undefined
Fault 24 	PVshort	<ol style="list-style-type: none"> 1.Please turn off the PV input and Check the voltage of the PV strings and the PV resistance of inverter side with multi-meter

		2. If the step above do not work,please contact Luxpowertek
Fault 25  <small>Fault</small>	Temperature over range	1. Please check if inverter is in work mode,it could be the problem of high temperature 2. If the inverter is in standby mode
Fault 26	Rsvd	Undefined
Fault 27	Rsvd	Undefined
Fault 28	Rsvd	Undefined
Fault 29	Rsvd	Undefined
Fault 30	Rsvd	Undefined
Fault 31  <small>Fault</small>	Internal communication fault4	1. Please try to restart the inverter to remove the error ; 2. Please check if the firmwares for both Comm and MPPT are well done ; 3. If the steps above do not work,please contact Luxpowertek

Warning Code	Warning decription	Trouble shooting
Warning 00  <small>Warning</small>	Communication failure with battery	1. Please check the PINs layout of the Comm cable(both inverter and battery side) ; 2. Please check if the Comm cable is at the correct comm port (CAN or RS485) 3. Please check the DIP configuration of the battery side 4. Please check the battery protocol(0.Standard 2.Pylon),refer to the compatible list
Warning 01	Rsvd	Undefined
Warning 02	Rsvd	Undefined
Warning 03  <small>Warning</small>	Communication failure with meter	This code is not for Eco-Hybrid
Warning 04  <small>Warning</small>	Battery failure (Both charge and discharge are not allowed by the BMS)	1. Please check the PINs layout of the Comm cable(both inverter and battery side) ; 2. Please check the battery protocol(0.Standard 2.Pylon),refer to the compatible list 3. Please check if there is alarm on the battery 4. Please contact the battery supplier
Warning 05	Rsvd	Undefined
Warning 06	Rsvd	Undefined
Warning 07	Rsvd	Undefined
Warning 08  <small>Warning</small>	Software mismatch	Please contact Luxpowertek

<p>Warning 09</p>  	<p>Fan Stuck</p>	<p>1. Please check if there is fan stuck issue. Fans control logic:When the charge or discharge power is higher than 300 Watts,the left and the middle fan will work , and when the PV power is higher than 300 Watts or import power from the grid higher than 5000VA, the right fan will work</p> <p>2. Please restart the inverter and check if the warning is still there</p> <p>3. Please contact Luxpowertek</p>
<p>Warning 10</p>	<p>Rsvd</p>	<p>Undefined</p>
<p>Warning 11</p>	<p>Rsvd</p>	<p>Undefined</p>
<p>Warning 12</p>  	<p>Bat On Mos</p>	<p>1. Please restart the inverter and check if the warning is still there</p> <p>2. Please contact Luxpowertek</p>
<p>Warning 13</p>  	<p>Overtemperature (NTC reading is too high)</p>	<p>1. Please check if there is fan stuck issue</p> <p>2. Please check if the wind chanel or vents are blocked</p> <p>3. Please do regular cleaning for the dust filters</p> <p>4. Please contact Luxpowertek</p>
<p>Warning 14</p>	<p>Rsvd</p>	<p>Undefined</p>
<p>Warning 15</p>	<p>Rsvd</p>	<p>Undefined</p>
<p>Warning 16</p>	<p>Rsvd</p>	<p>Undefined</p>
<p>Warning 17</p>	<p>Rsvd</p>	<p>Undefined</p>
<p>Warning 18</p>  	<p>AC Frequency out of range</p>	<p>Power off the inverter and turn on the AC first to let the inverter self-adjust to the grid frequency</p>
<p>Warning 19</p>	<p>Rsvd</p>	<p>Undefined</p>
<p>Warning 20</p>	<p>Rsvd</p>	<p>Undefined</p>
<p>Warning 21</p>	<p>Rsvd</p>	<p>Undefined</p>
<p>Warning 22</p>	<p>Rsvd</p>	<p>Undefined</p>
<p>Warning 23</p>	<p>Rsvd</p>	<p>Undefined</p>

Warning 24	Rsvd	Undefined
Warning 25  Warning 	Battery voltage high	<ol style="list-style-type: none"> 1. Please check the operation range of the battery and make sure is within the range:40-59Vdc, if not ,please power off the battery and disconnect it from the system. 2. Please contact Luxpowertek
Warning 26  Warning 	Battery voltage low	<ol style="list-style-type: none"> 1. Please check the setting of warning low voltage and SOC 2. Please check if the battery output is really low
Warning 27  Warning 	Battery open	<ol style="list-style-type: none"> 1. Please check if the battery is connected 2. Please check if the breaker state of the battery side 3. Please check if the battery has run out and protected itself 4. Please contact Luxpowertek
Warning 28  Warning 	EPS Over load	<ol style="list-style-type: none"> 1. Please check if the EPS load is too high to work 2. Please check if the PV and battery is not powerful enough to take the loads. 3. Please contact Luxpowertek
Warning 29  Warning 	EPS voltage high	<ol style="list-style-type: none"> 1. Please check if there is a device of surge power working and the recovery time will be 20minutes to remove this warning 2. Please contact Luxpowertek
Warning 30	rsvd	Undefined
Warning 31  Warning 	EPS DCV high	Please contact Luxpowertek

NB: Refer to Fault Code Guide Even if Both Warning and Fault Face is Displaying on LCD Screen.

Battery Brand (LV battery series)	Protocol Type				Compatible Model		
	CAN	Battery Code	RS485	Battery Code	Hybrid Inverter	ECO Hybrid Inverter	AC Coupled Inverter
Pylon (派能)	Pylon	2	/	/	✓	✓	✓
Dyness (大秦)	Dyness	8	/	/	✓	✓	✓
Meritsun	/	/	LUX	6/11	✓	✓	✓
Aoboet (奥波)	Aoboet	7	/	/	✓	✓	✓
Weco	Weco	14	/	/	✓		
Murata	/	/	Murata	15	✓		
Shoto (双登)	Pylon	2	/	/	✓	✓	✓
Revov	Pylon	2	Pylon(9600bps)	4	✓	✓	✓
Zerata (泽塔)	LUX	6	LUX	6	✓	✓	✓
UZ Energy (昱泽)	LUX	6	/	/	✓	✓	✓
EENOVANCE (盛齐)	Pylon	2	/	/	✓		
Hubble	Pylon	2	/	/	✓	✓	
CF Energy	LUX	6	/	/	✓	✓	